

A.

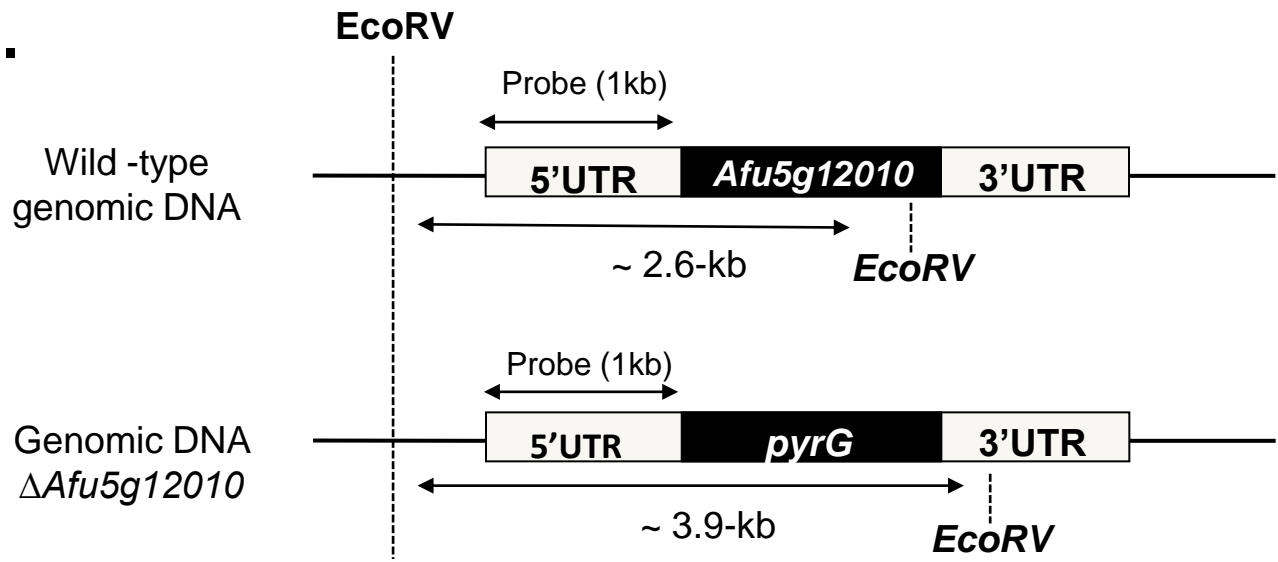

Afu5g12010

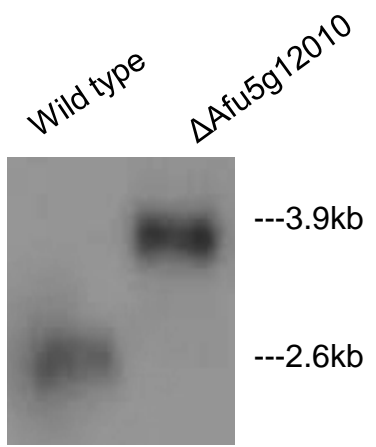

B.

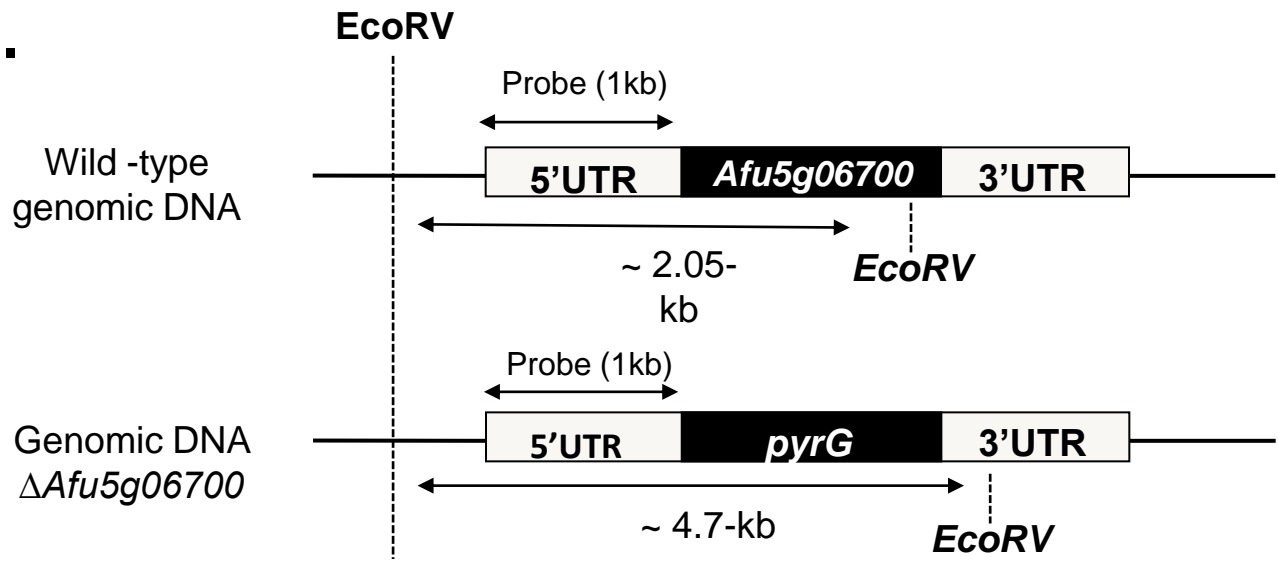

Afu5g06700

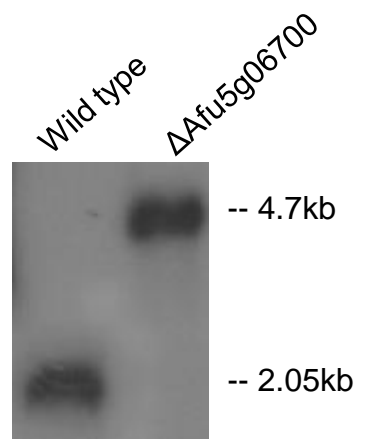

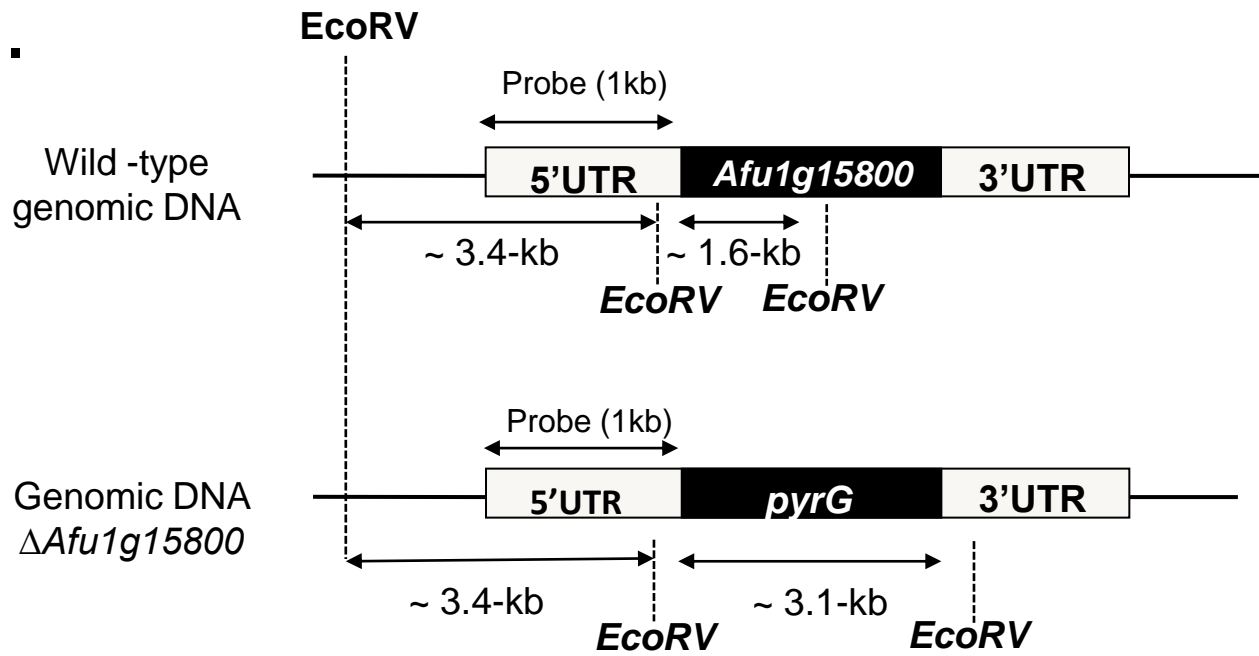
C.

Afu1g15800

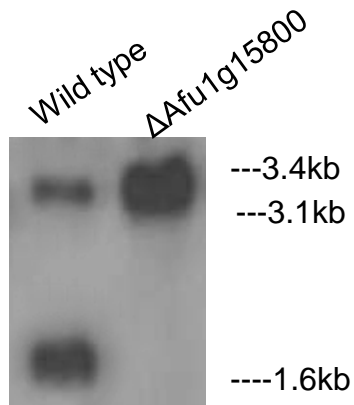

D.

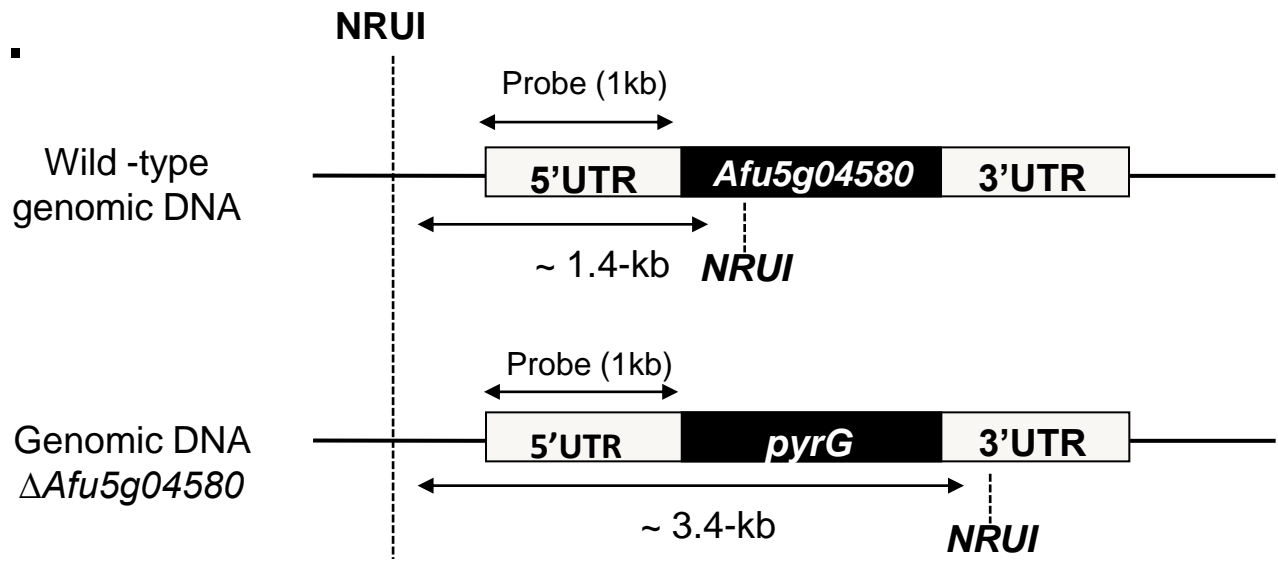

Afu5g04580

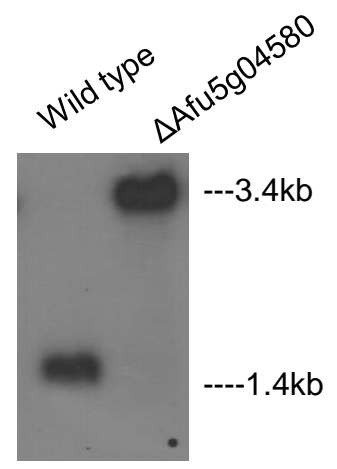

E.

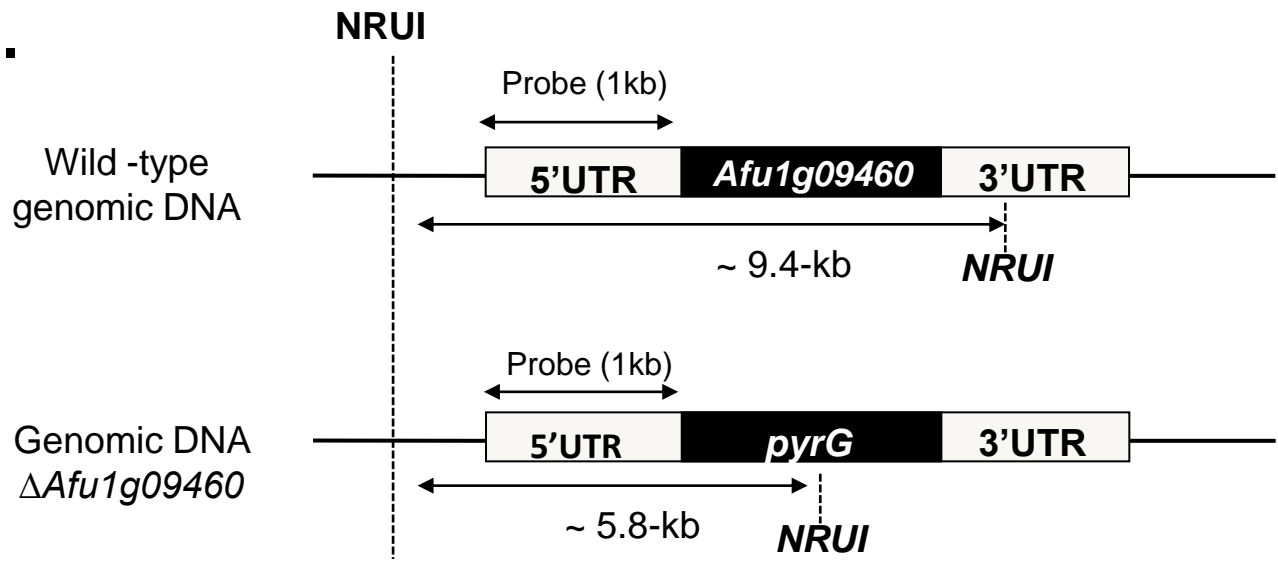

Afu1g09460

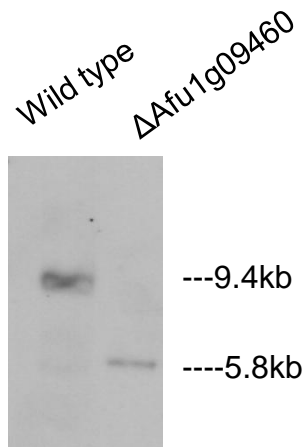

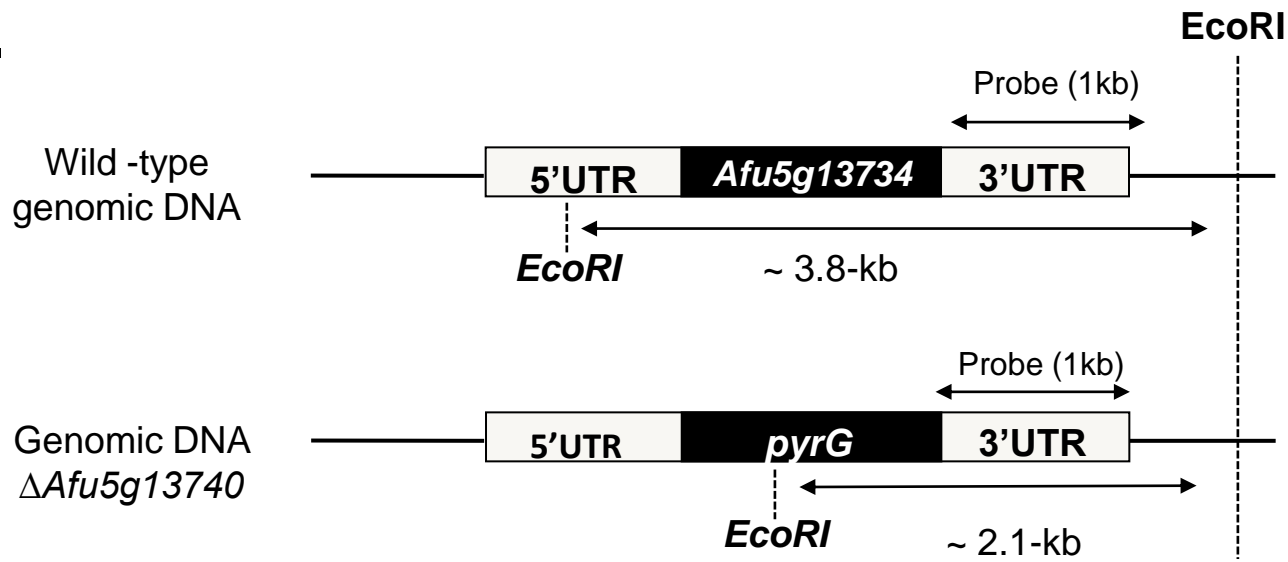
F.

Afu5g13740

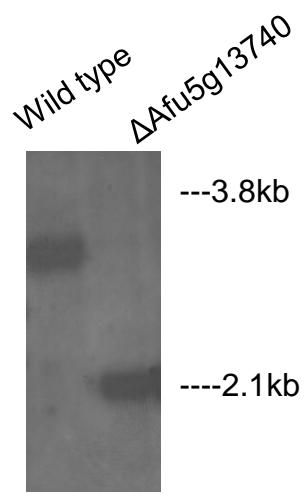

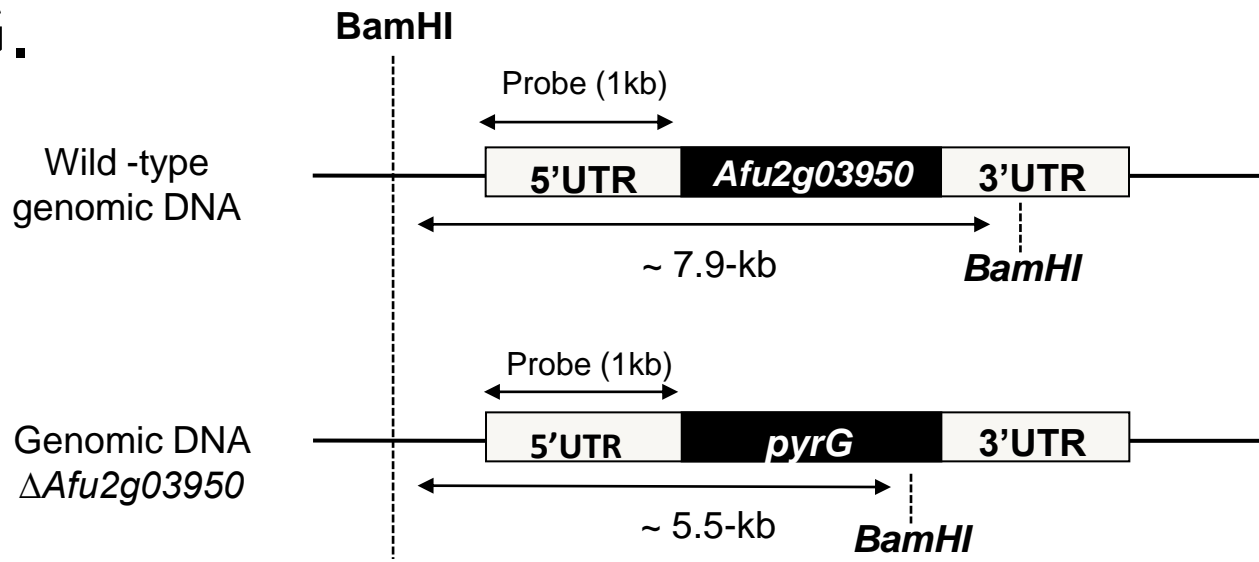
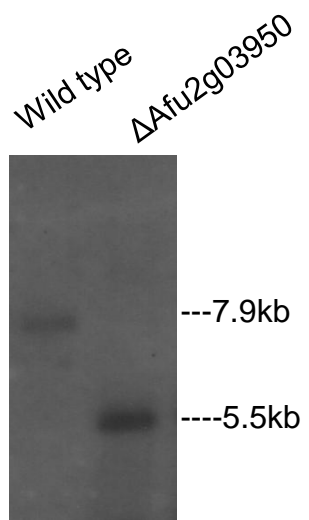
G.**Afu2g03950**

H.

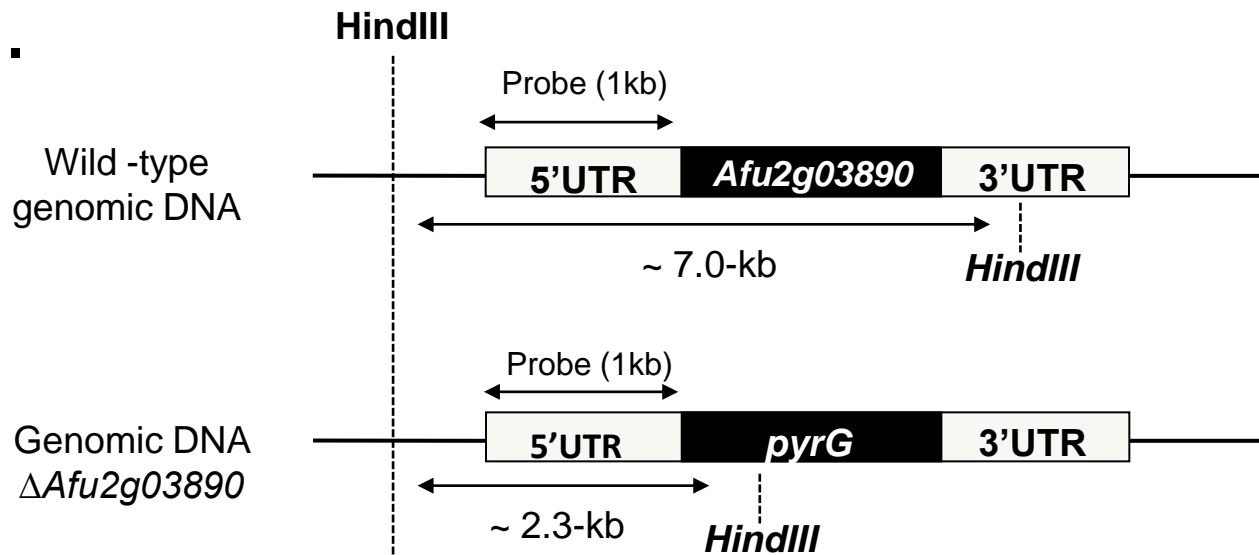

Afu2g03890

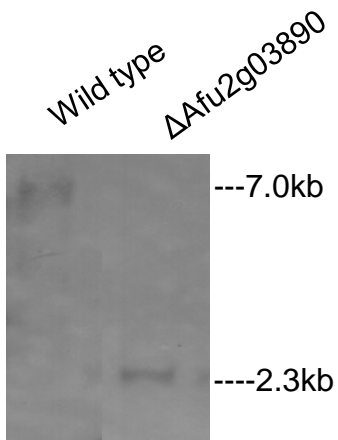

I.

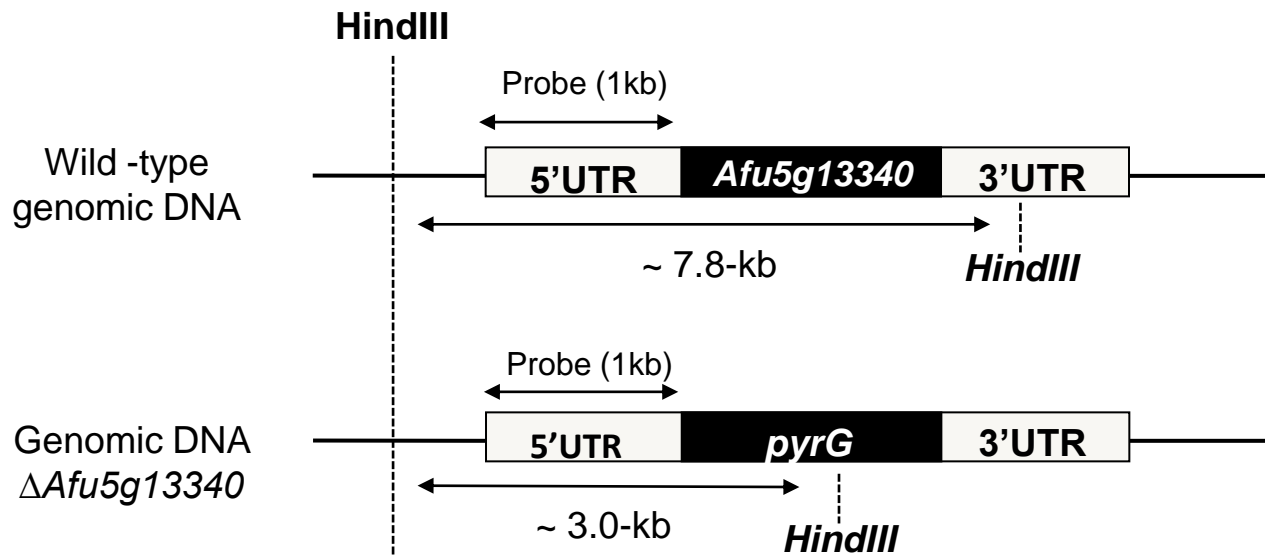

Afu5g1334

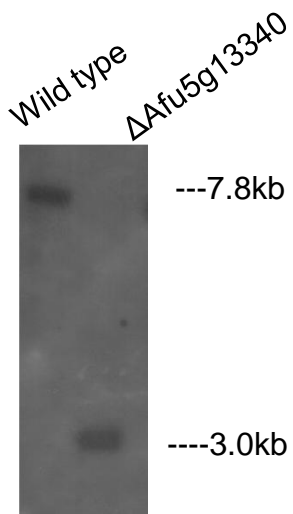

J.

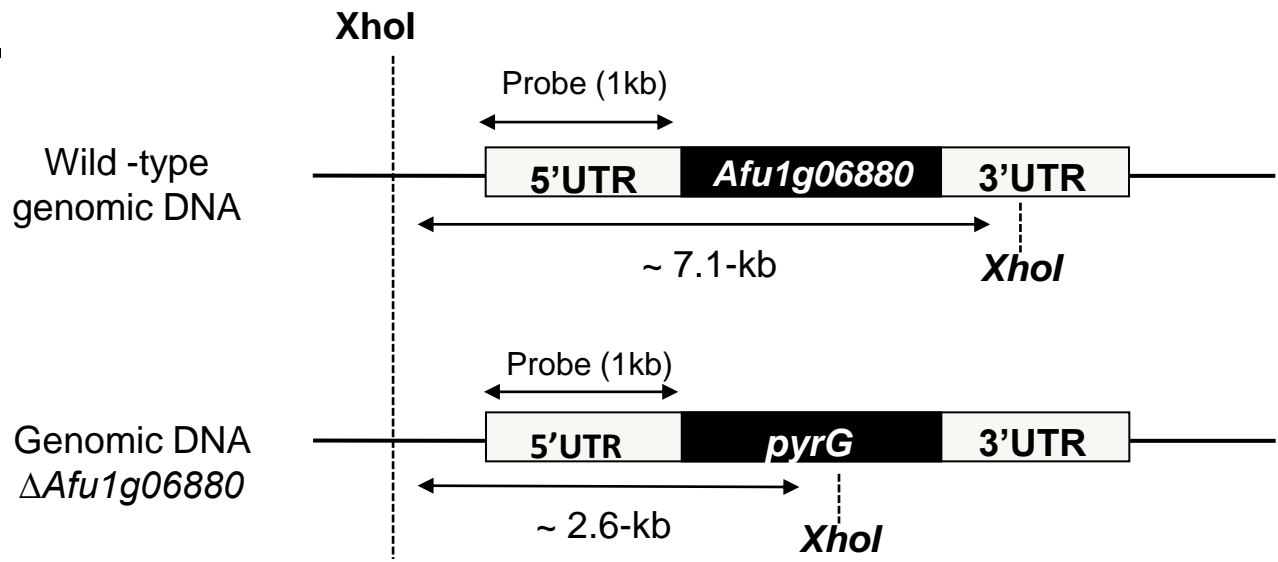

Afu1g06880

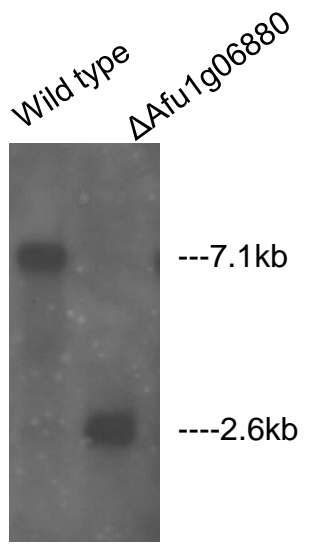

K.

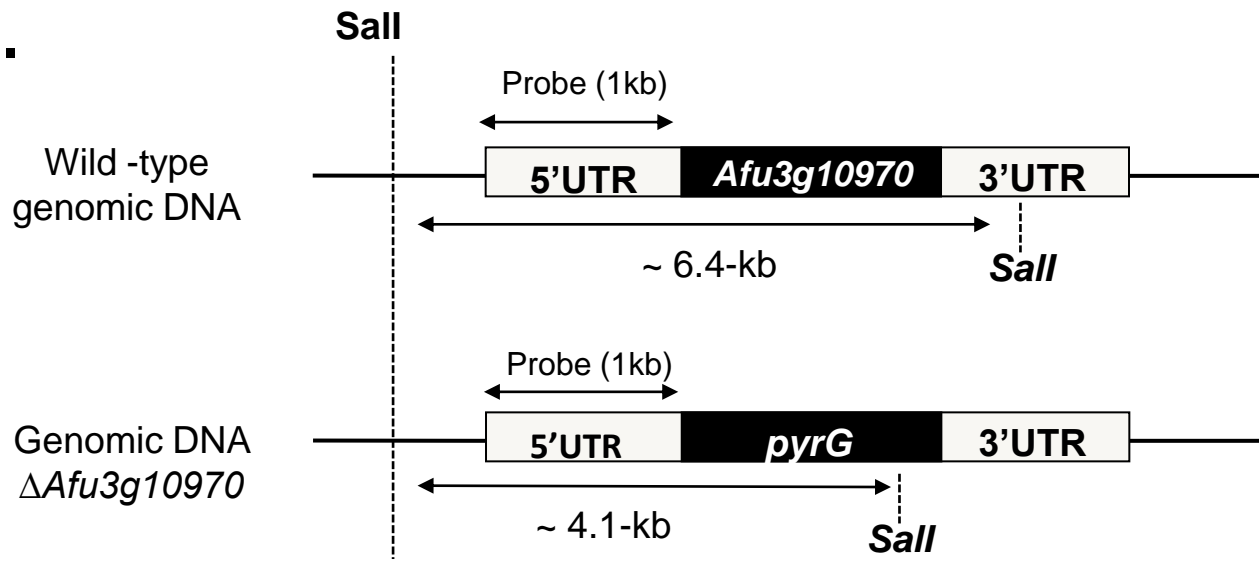

Afu3g10970

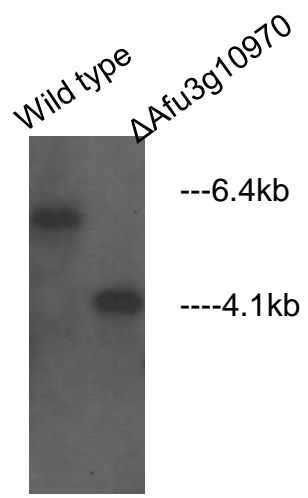

L.

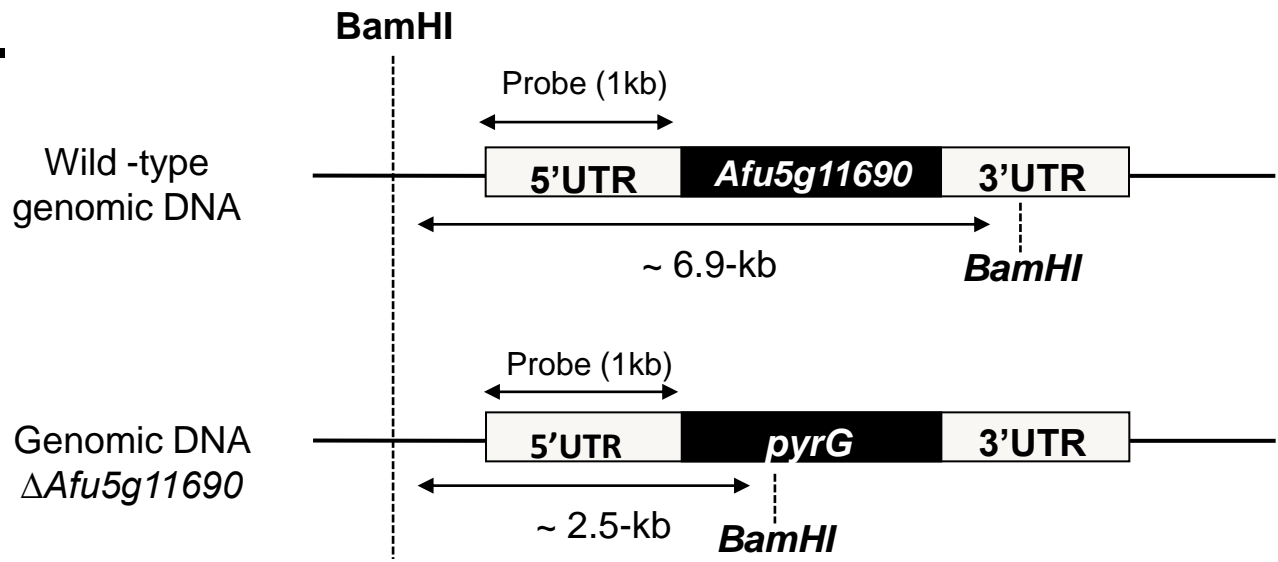

Afu5g11690

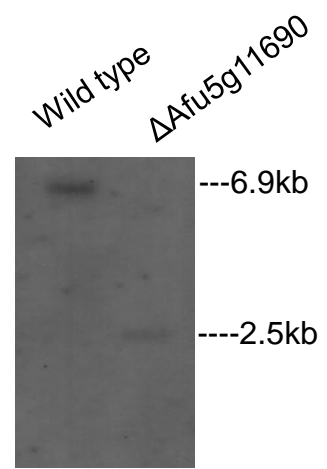

M.

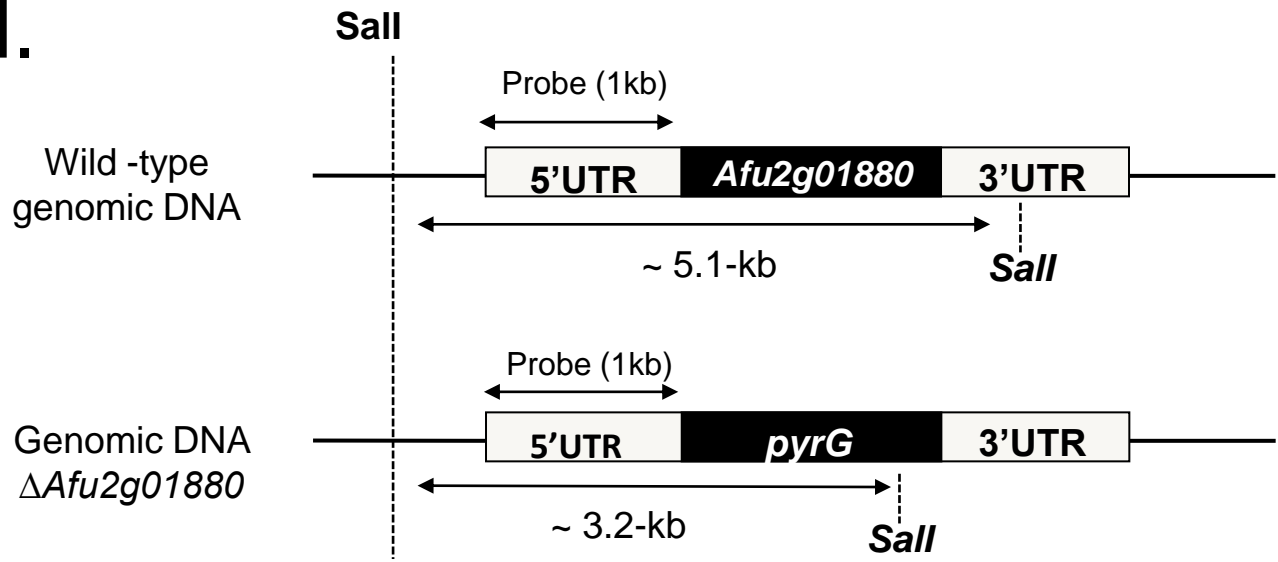

Afu2g01880

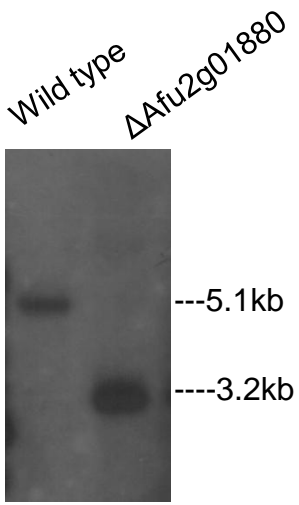

N.

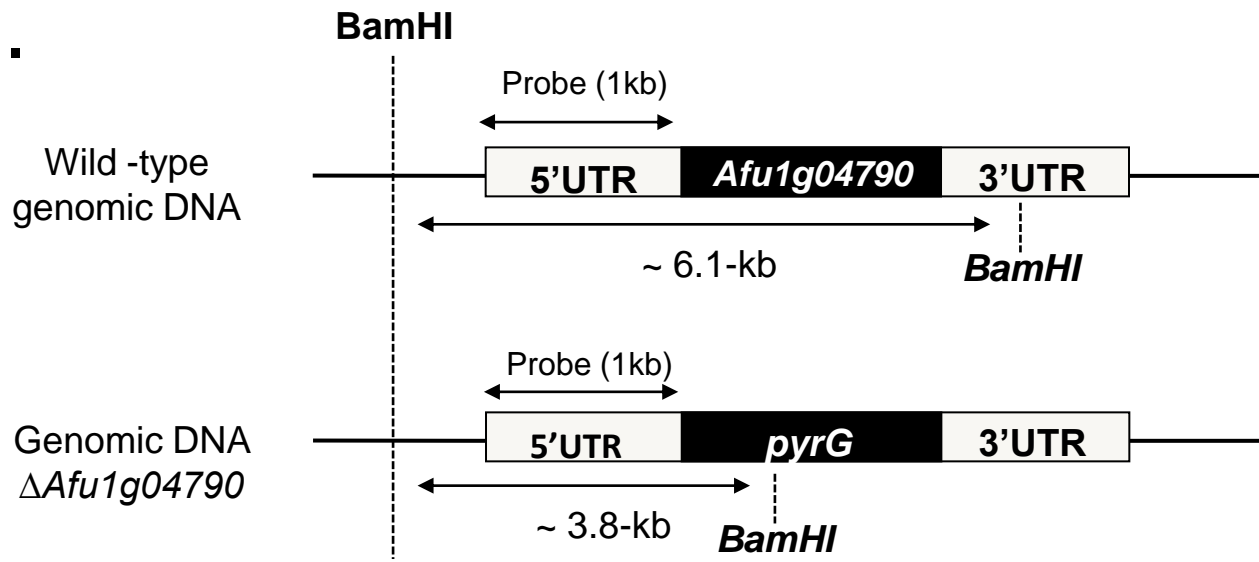

Afu1g04790

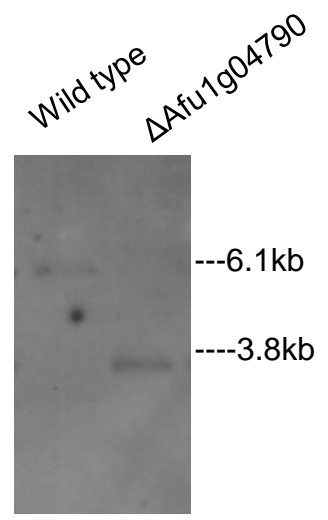

O.

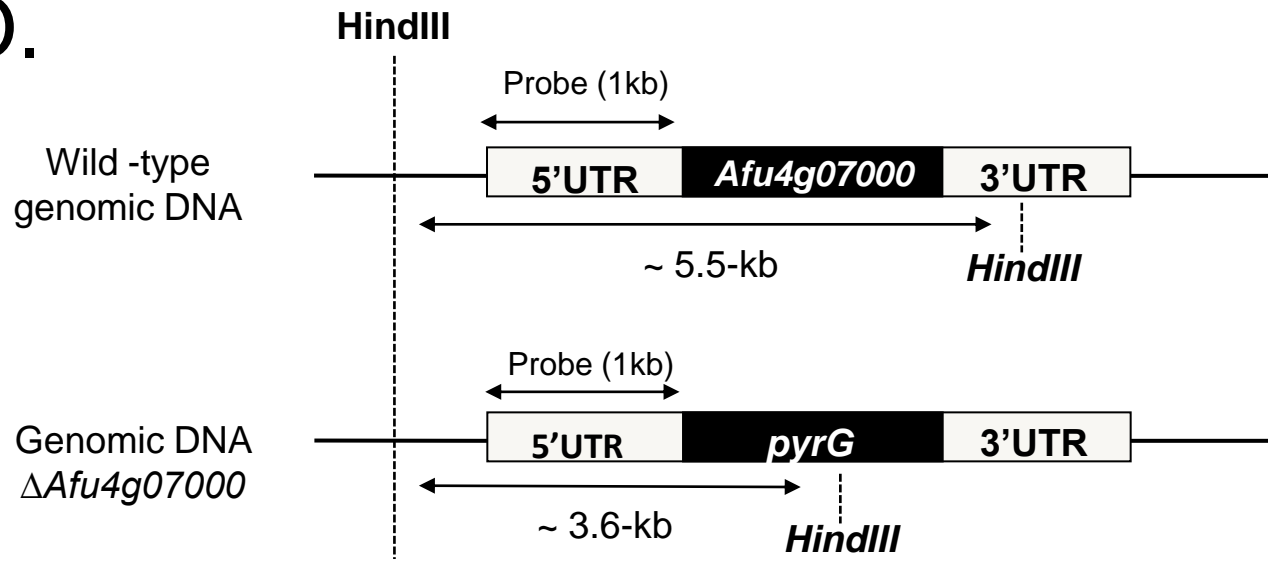

Afu4g07000

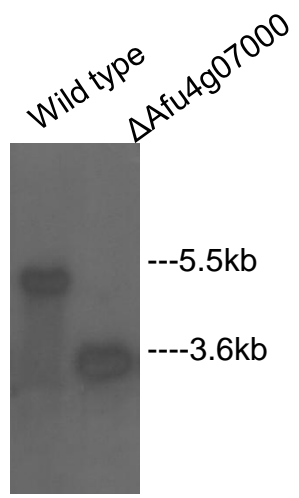

P.

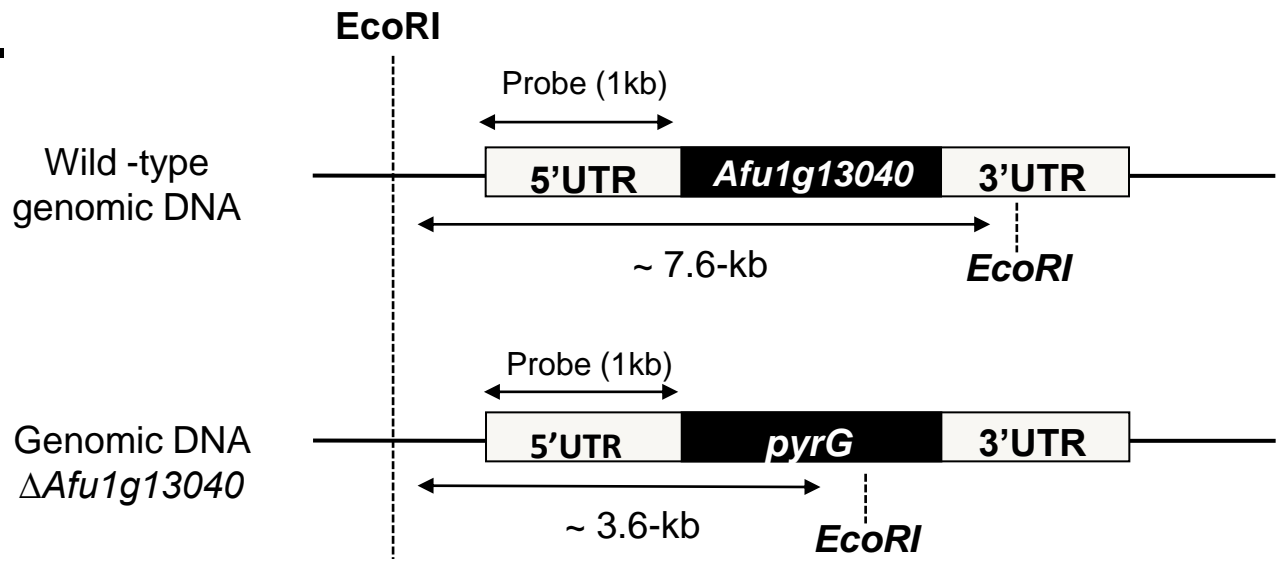

Afu1g13040

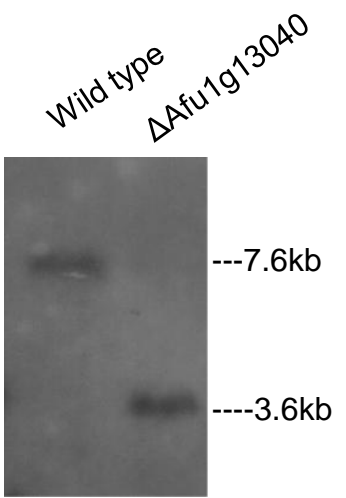

Q.

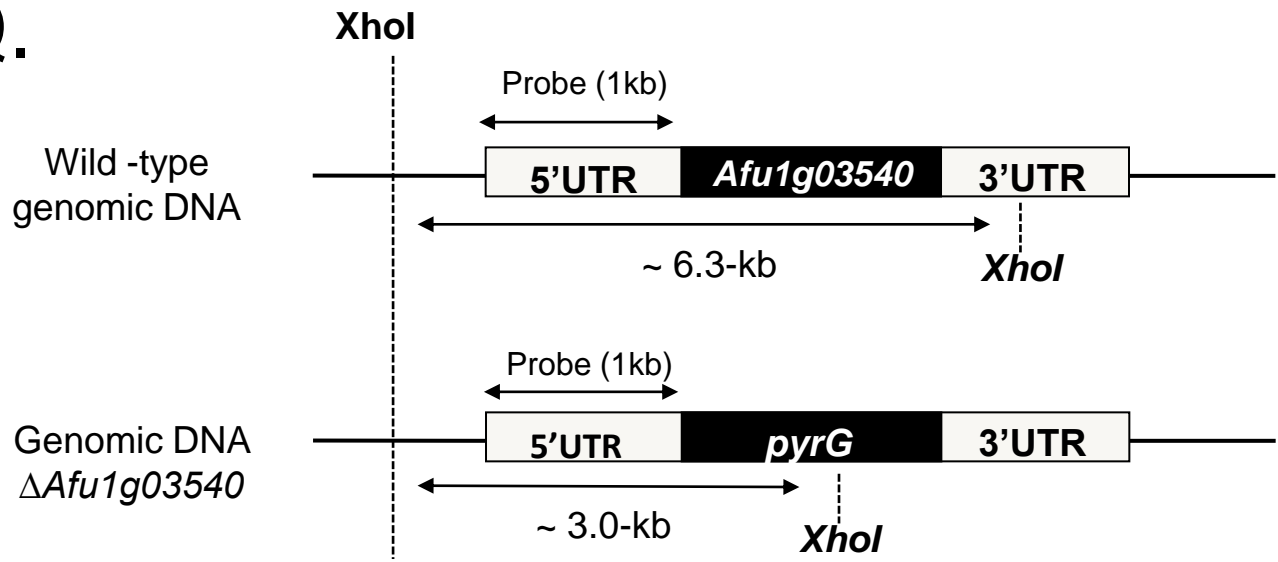

Afu1g03540

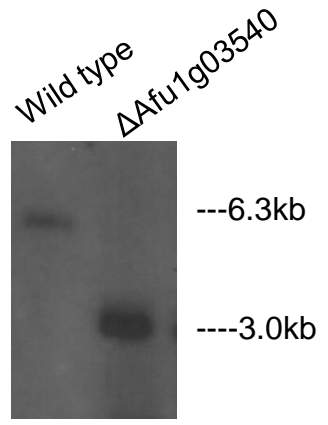

R.

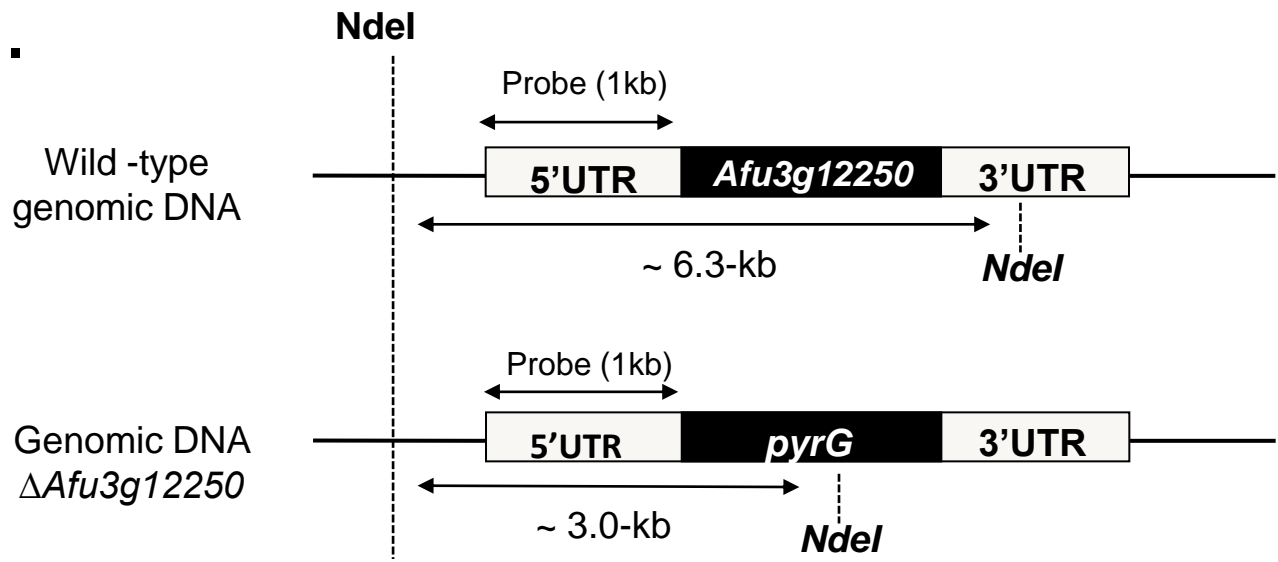

Afu3g12250

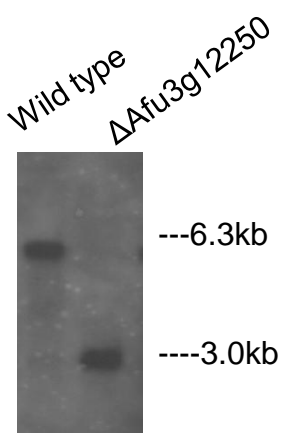

S.

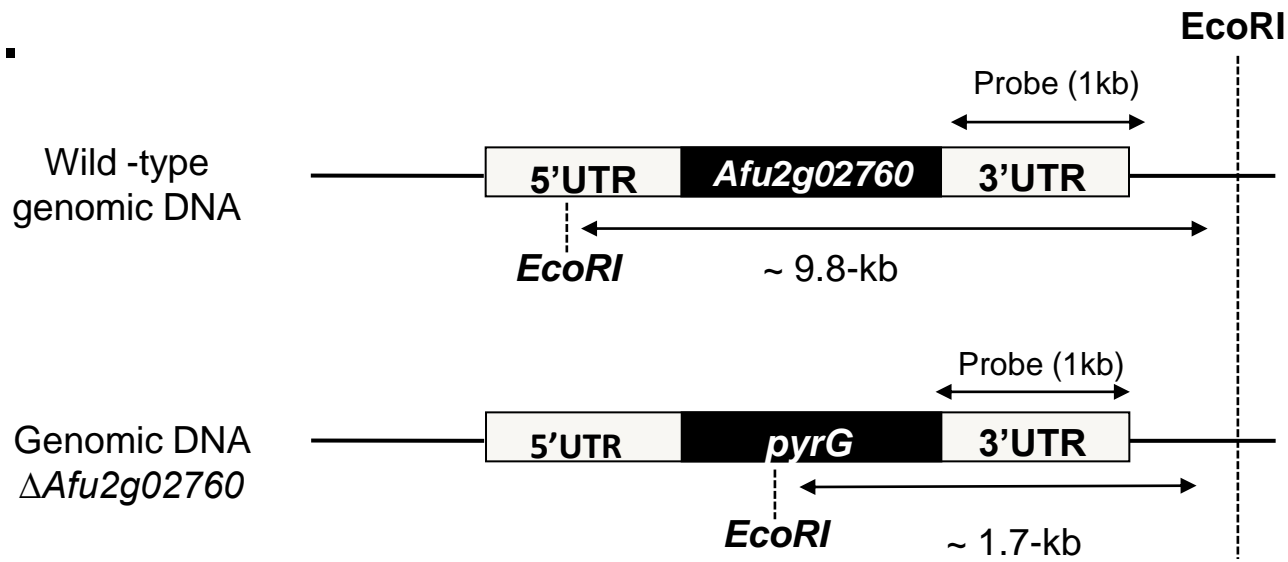

Afu2g02760

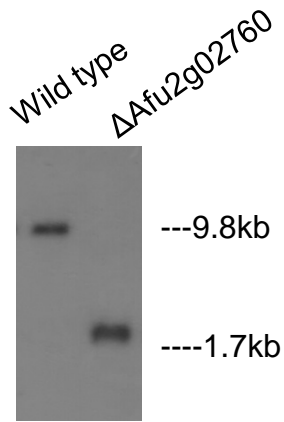

T.

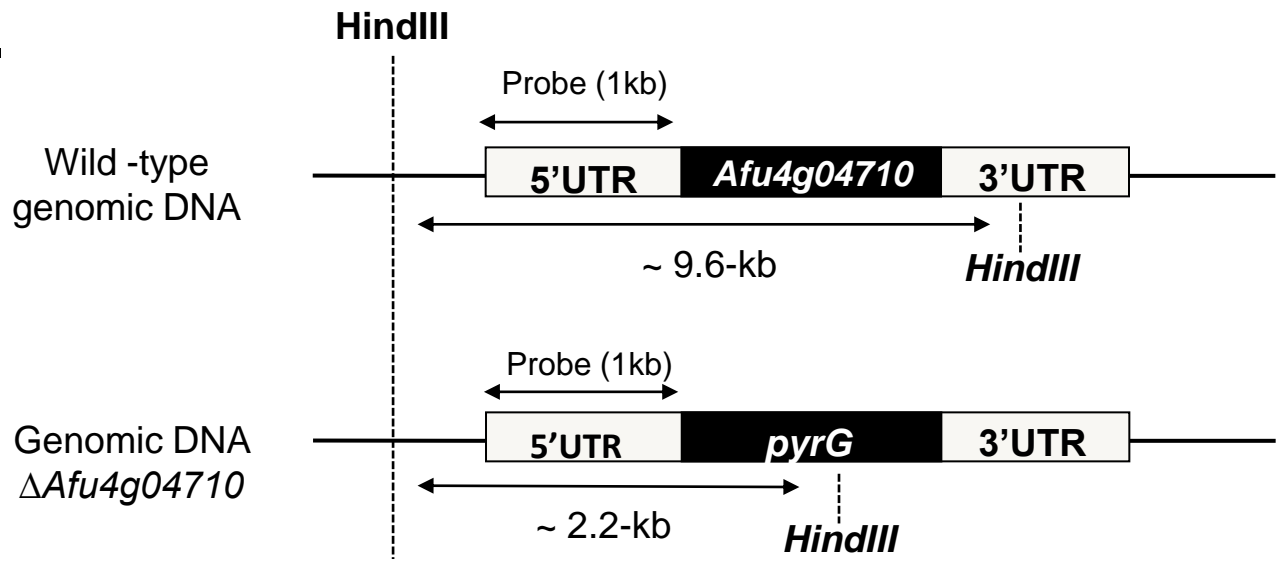

Afu4g04710

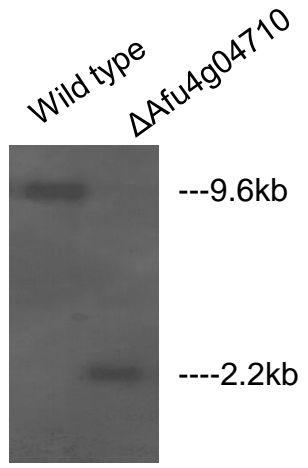

U.

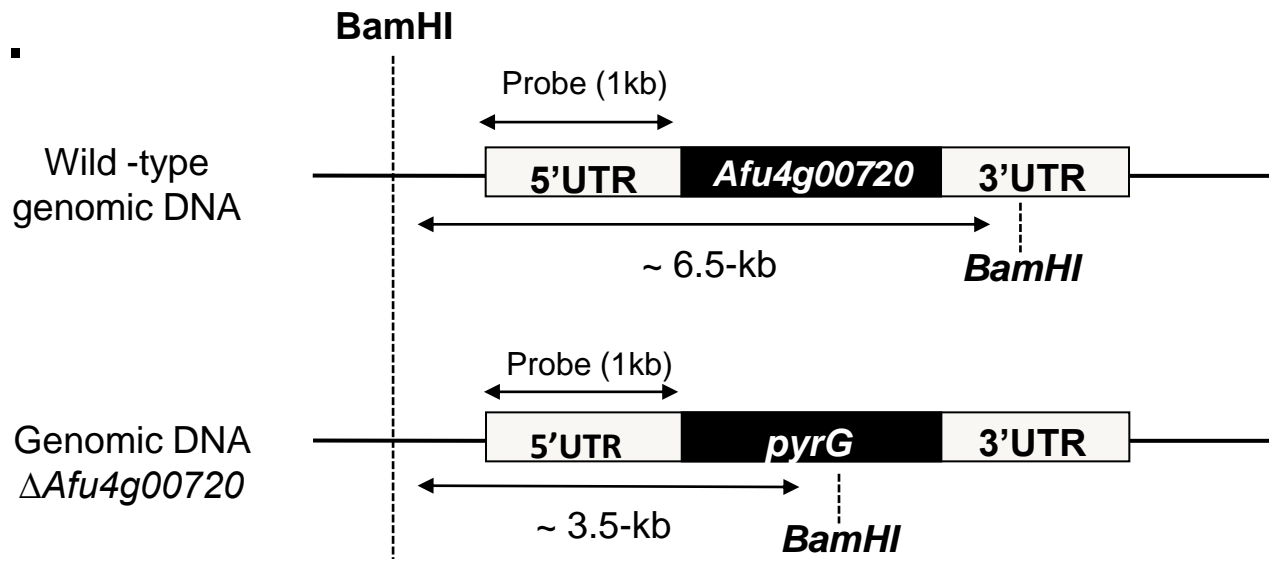

Afu4g00720

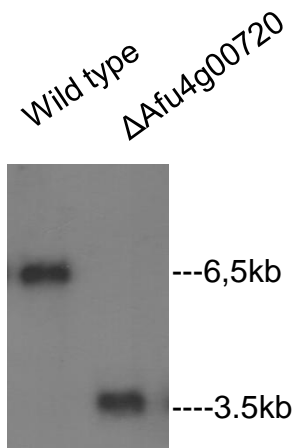

V.

Sall

Wild -type
genomic DNA

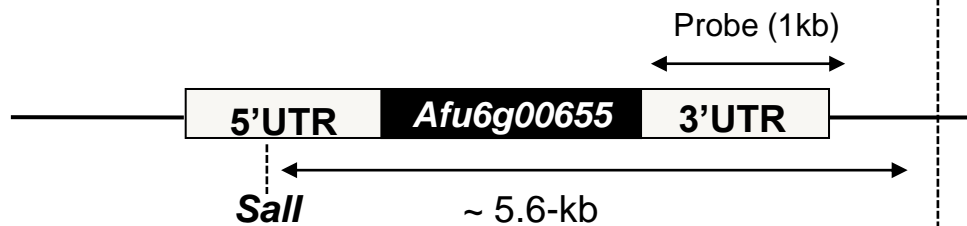

Genomic DNA
 Δ *Afu6g06650*

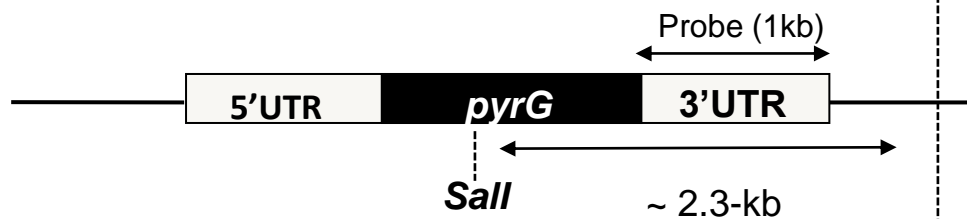

Afu6g06650

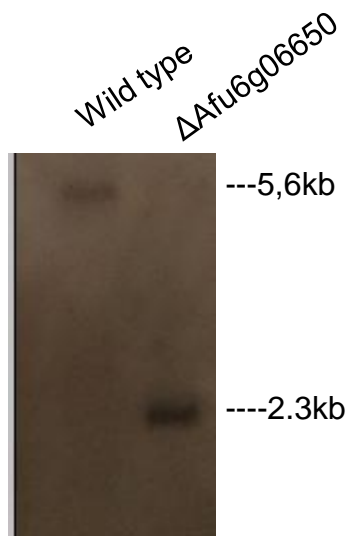

X.

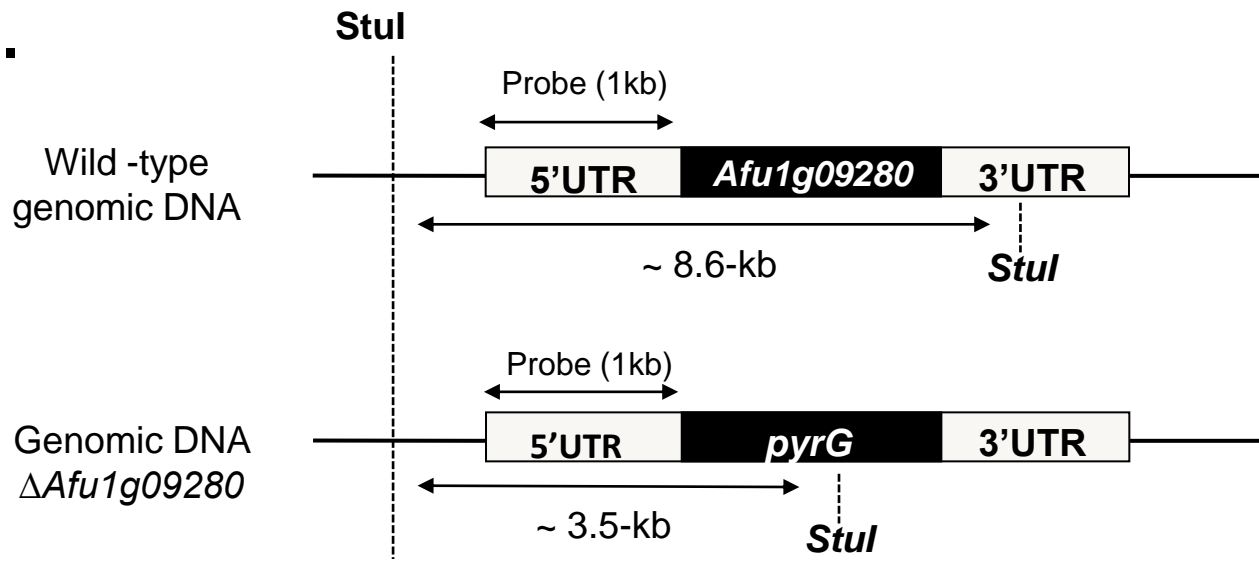

Afu1g09280

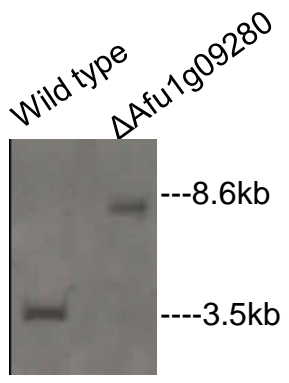

Y.

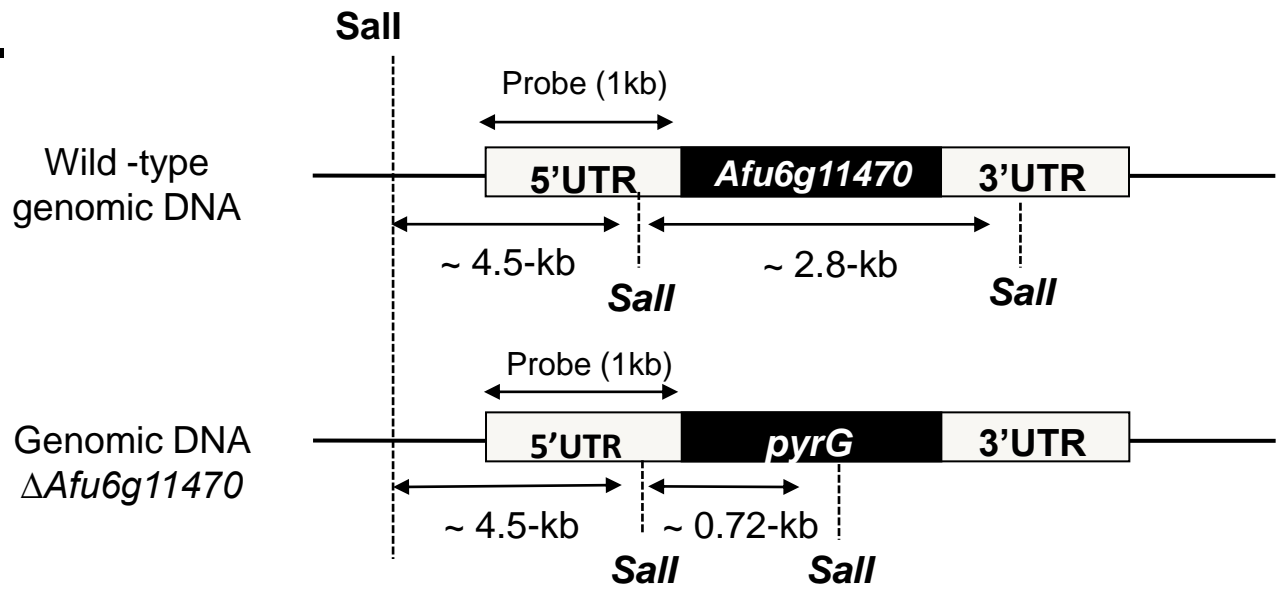

Afu6g11470

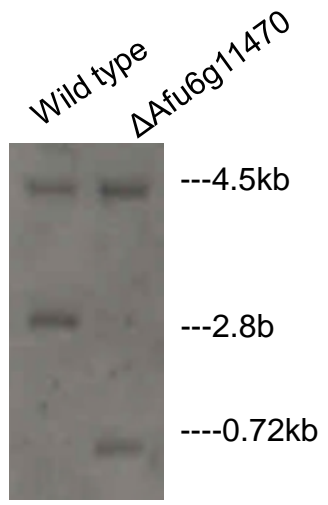

Complementation of delta *Afu1g09280*

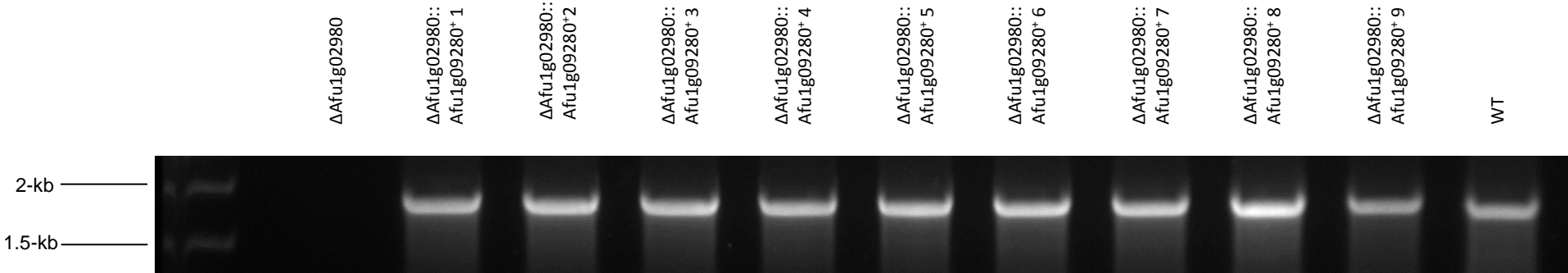
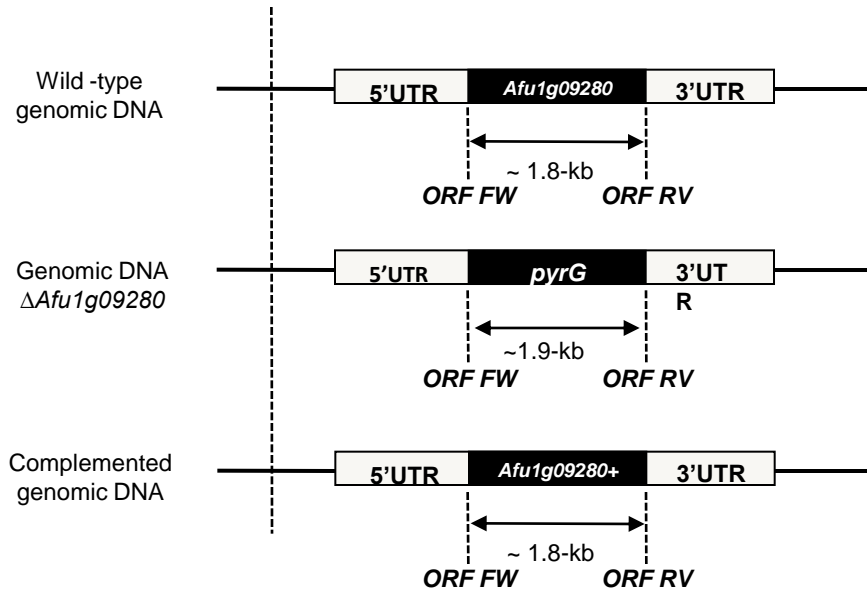

Z.

Wild -type
genomic DNA



Addition of *niiA* promoter in
genomic DNA

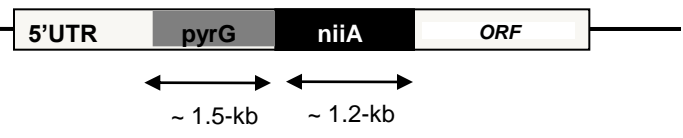

Figure S1 – Southern blot analysis for all the phosphatase deletion mutants (A to Y), Complementation analysis (W), and strategy to fuse *niiA* promoter to the essential genes (Z).

.